



## CHI SIAMO

---

Nati da un piccolo laboratorio artigiano nel 1889, siamo oggi un brand di fama internazionale ispirato ai più alti standard qualitativi del Made in Italy.

Per garantire la massima qualità possibile, miglioriamo sempre i nostri prodotti, scegliamo tecnologie all'avanguardia e abbiamo il controllo sull'intera filiera produttiva.

# L'ECCELLENZA COSTRUTTIVA

---

**RIVESTIMENTI ANTIADERENTI  
ALTOPERFORMANTI**

**VARIETÀ DEI MATERIALI**

**ALTO SPESSORE**

**MANICATURE ERGONOMICHE**

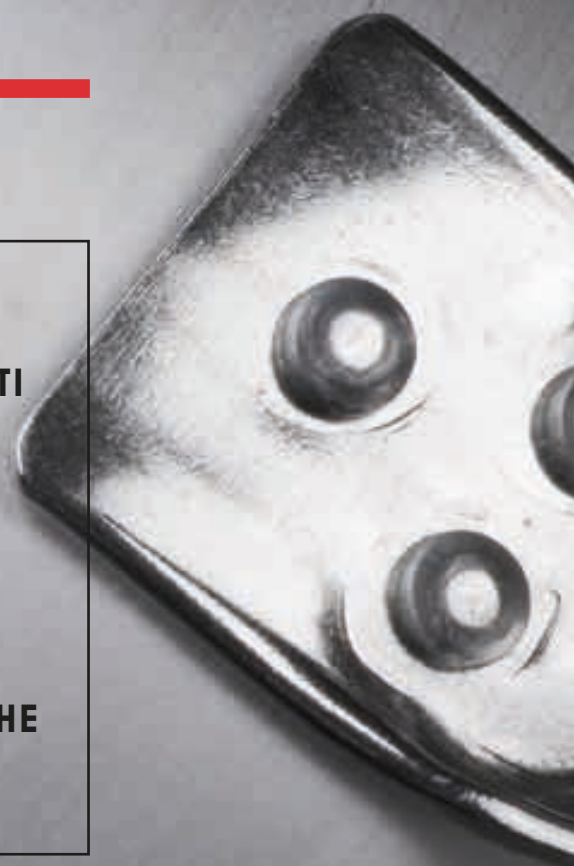

# RIVESTIMENTI ANTIADERENTI **KERASTONE**

---

SONO I NOSTRI RIVESTIMENTI  
ANTIADERENTI **ALTAMENTE**  
**PERFORMANTI**  
SVILUPPATI PER IL SETTORE  
PROFESSIONALE.

**KERASTONE** TESTATO  
PER GARANTIRE  
LA **SUPERIORE QUALITÀ DI**  
**ANTIADERENZA**  
**E RESISTENZA ALL' ABRASIONE.**

# RIVESTIMENTI ANTIADERENTI KERASTONE

Sviluppati per garantire la superiore qualità  
di antiaderenza e resistenza all'abrasione

## BLACK



l'antiaderente  
tradizionale



## GRANITE



l'antiaderente con particelle  
minerali "effetto pietra".



# NUOVO FONDO A INDUZIONE

---

- ANTIGRAFFIO
- GRANDI PERFORMANCE DI ASSORBIMENTO DI POTENZA
- FONDO INDUZIONE PER IL MASSIMO RENDIMENTO
- FONDO ANTI-DISTACCAMENTO: DISCO IN ACCIAIO E CIOTOLA IN ALLUMINIO SI SALDANO IN UN CORPO UNICO



# MANICATURE

La manicazione Ballarini Professionale è stata sviluppata per superare i test di fatica, flessione e torsione con elevati coefficienti di sicurezza.



PARTE TERMINALE DEL MANICO STUDIATA PER FAVORIRE IL MOVIMENTO NELLA COTTURA AL SALTO

FORMA ERGONOMICA "A PIENA PRESA"

NERVATURE RINFORZATE



## **I MATERIALI UTILIZZATI**

---

### **ALLUMINIO BIANCO**

Il materiale più trasversale  
e il più utilizzato nella cucina professionale







### **ALLUMINIO ANTIADERENTE**

Il materiale ideale per le più variegate  
esigenze di cottura

### **ACCIAIO**

Acciai multistrato, per un'ottima gestione  
della temperatura

# CATALOGO 2023

LINEA	MATERIALE	RIVESTIMENTO	MM	INDUZIONE
 <b>7000</b>	<b>ALLUMINIO BIANCO</b>		<b>2,5 4,0</b>	
 <b>2000</b>	<b>ALLUMINIO ANTIADERENTE</b>		<b>2,5 4,0</b>	
 <b>2100</b>	<b>ALLUMINIO ANTIADERENTE</b>		<b>3,0</b>	
 <b>2800</b>	<b>ALLUMINIO ANTIADERENTE</b>		<b>3,0</b>	



LINEA	MATERIALE	RIVESTIMENTO	MM	INDUZIONE
 <p><b>6800</b></p>	<p><b>ALLUMINIO BIANCO</b></p>		<p><b>4,0</b></p>	<p><b>INDUCTION</b></p> 
 <p><b>6700</b></p>	<p><b>ALLUMINIO ANTIADERENTE</b></p>		<p><b>4,0</b></p>	<p><b>INDUCTION</b></p> 
 <p><b>6900</b></p>	<p><b>ALLUMINIO ANTIADERENTE</b></p>		<p><b>4,0</b></p>	<p><b>INDUCTION</b></p> 
 <p><b>6000</b></p>	<p><b>ALLUMINIO ANTIADERENTE</b></p>		<p><b>4,0</b></p>	<p><b>INDUCTION</b></p> 
 <p><b>9200</b></p>	<p><b>ACCIAIO INOX 18/10</b></p>			<p><b>INDUCTION</b></p> 

# INDICE

---

LINEA 7000	pag.12
LINEA 2000	pag.24
LINEA 2100	pag.30
LINEA 2800	pag.34
LINEA 6800	pag.38
LINEA 6700	pag.42
LINEA 6900	pag.46
LINEA 6000	pag.50
LINEA 9200 - ACCESSORI E MESTOLAME	pag.54



# SERIE 7000

2,5 MM - 4 MM - ALLUMINIO BIANCO

## LINEA PROFESSIONALE IN ALLUMINIO

Made in Italy



### Finitura esterna

Alluminio lavato decapato  
neutralizzato

### Finitura interna

Alluminio lavato decapato  
neutralizzato

### Spessore costante

Compreso tra  
mm 2,5 e mm 4,0

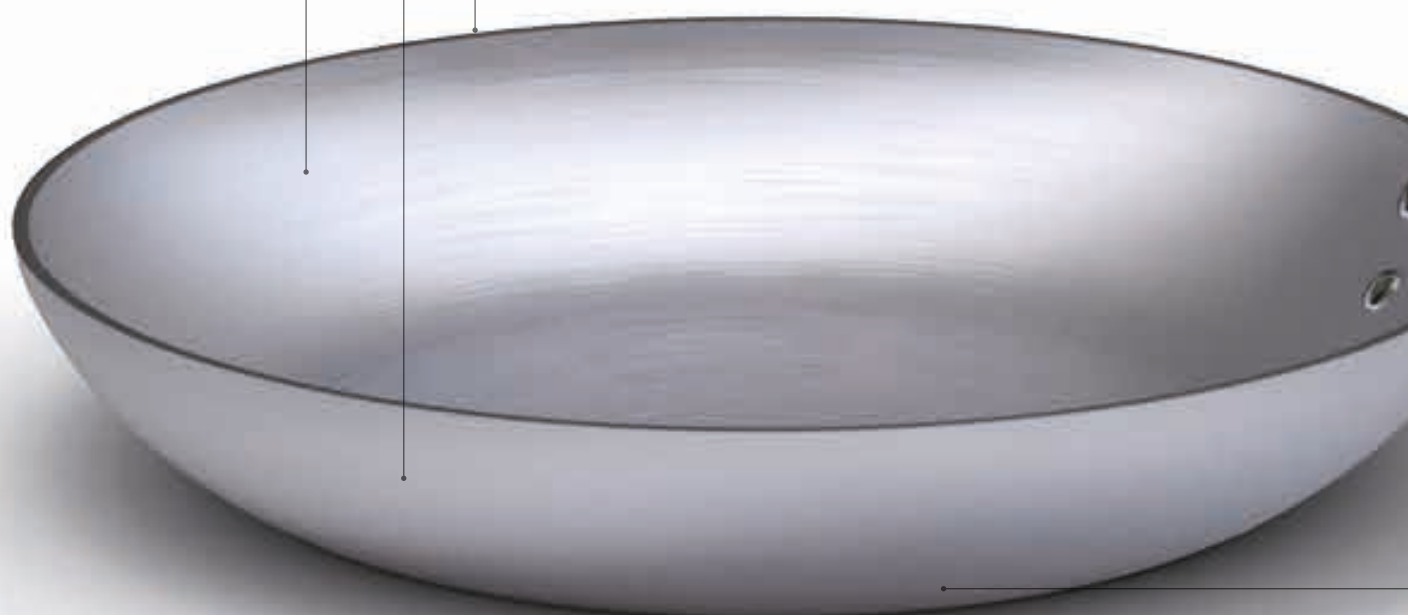



## Manicatura

Manicatura professionale in acciaio inox a nervatura rinforzata

## Fondo

Fondo ad alto spessore costante per un'ottima distribuzione e assorbimento del calore.

## Fonti di riscaldamento



# SERIE 7000

2,5 MM - 4 MM - ALLUMINIO BIANCO



## 7000

Padella svasata bassa 1 manico



SAP	Ref.	Ø cm	H	Pack.	EAN	Prezzo cons.*
1001760	7000.20	20	4,5	6 PZ.	8003150457382	€ 20,00
1001761	7000.22	22	4,5	6 PZ.	8003150457399	€ 22,00
1000175	7000.24	24	4,5	6 PZ.	8003150457405	€ 25,00
1006430	7000.26	26	4,5	6 PZ.	8003150457412	€ 26,50
1000176	7000.28	28	5,0	6 PZ.	8003150457429	€ 28,50
1006431	7000.30	30	5,0	6 PZ.	8003150457436	€ 30,50
1000177	7000.32	32	5,0	6 PZ.	8003150457443	€ 32,50
1000178	7000.36	36	5,5	3 PZ.	8003150457450	€ 47,50
1000179	7000.40	40	6,0	3 PZ.	8003150457467	€ 55,00
1001762	7000.45	45	6,5	3 PZ.	8003150457474	€ 78,00

## 7002

Padella svasata alta 1 manico



SAP	Ref.	Ø cm	H	Pack.	EAN	Prezzo cons.*
1000180	7002.20	20	5,5	6 PZ.	8003150457283	€ 22,00
1000181	7002.24	24	7,0	6 PZ.	8003150457306	€ 27,50
1006433	7002.26	26	7,0	6 PZ.	8003150457313	€ 29,50
1000182	7002.28	28	7,0	6 PZ.	8003150457320	€ 35,00
1000183	7002.32	32	7,5	6 PZ.	8003150457344	€ 38,00
1000184	7002.36	36	8,0	3 PZ.	8003150457351	€ 52,50
1000185	7002.40	40	8,5	3 PZ.	8003150457368	€ 60,00
1000186	7002.45	45	10,0	3 PZ.	8003150457375	€ 84,00

## 7001

Padella svasata bassa 1 manico + maniglia



SAP	Ref.	Ø cm	H	Pack.	EAN	Prezzo cons.*
1005200	7001.45	45	6,5	3 PZ.	8003150513378	€ 78,00

## 7003

Padella svasata alta 1 manico + maniglia



SAP	Ref.	Ø cm	H	Pack.	EAN	Prezzo cons.*
1003691	7003.45	45			8003150513354	€ 84,00

# SERIE 7000

2,5 MM - 4 MM - ALLUMINIO BIANCO



## 7004

Padella dritta "a friggere" 1 manico



SAP	Ref.	Ø cm	H	Pack.	EAN	Prezzo cons.*
1001753	7004.24	24	6,0	6 pz.	8003150457214	€ 28,50
1001754	7004.28	28	6,5	6 pz.	8003150457221	€ 34,50
1001755	7004.32	32	6,5	6 pz.	8003150457238	€ 39,00
1001756	7004.36	36	6,5	3 pz.	8003150457245	€ 56,00
1001757	7004.40	40	7,0	3 pz.	8003150457252	€ 61,00

## 7008

Tegame 2 maniglie



SAP	Ref.	Ø cm	H	Pack.	EAN	Prezzo cons.*
1001763	7008.20	20	5,5		8003150457481	€ 23,00
1000189	7008.24	24	6,0		8003150457498	€ 29,50
1000190	7008.28	28	6,5		8003150457504	€ 34,50
1000191	7008.32	32	6,5		8003150457511	€ 40,00
1000192	7008.36	36	6,5		8003150457528	€ 52,50
1000193	7008.40	40	7,0		8003150457535	€ 61,00
1000194	7008.45	45	8,0		8003150457542	€ 85,00
1001764	7008.50	50	8,5		8003150457559	€ 106,00
1002292	7008.60	60	10,0		8003150464649	€ 138,00

## 7006

Padella wok "a mantecare" 1 manico



SAP	Ref.	Ø cm	H	Pack.	EAN	Prezzo cons.*
1000187	7006.24	24	7,5		8003150458235	€ 32,50
1000188	7006.28	28	8,8		8003150458242	€ 44,00

## 7016

Casseruola bassa 2 maniglie



SAP	Ref.	Ø cm	H	Lt	Pack.	EAN	Prezzo cons.*
1000196	7016.24	24	8,5	3,6		8003150457580	€ 32,50
1000197	7016.28	28	10,5	6,0		8003150457603	€ 46,00
1000198	7016.32	32	10,5	8,0		8003150457627	€ 51,00
1000199	7016.36	36	11,5	11,0		8003150457634	€ 63,00
1000200	7016.40	40	14,0	16,6		8003150457641	€ 82,00
1000201	7016.45	45	16,0	24,6		8003150457658	€ 111,00
1000202	7016.50	50	17,0	32,5		8003150457665	€ 138,00
1000203	7016.60	60	21,5	60,5		8003150464458	€ 198,00

# SERIE 7000

2,5 MM - 4 MM - ALLUMINIO BIANCO



## 7018

Casseruola media 2 maniglie



SAP	Ref.	Ø cm	H	Lt	Pack.	EAN	Prezzo cons.*
1001769	7018.18	18	10,0	2,3		8003150457689	€ 25,00
1000204	7018.20	20	11,5	3,2		8003150457696	€ 31,50
1000205	7018.24	24	13,5	5,5		8003150457719	€ 40,00
1000206	7018.28	28	16,5	9,2		8003150457733	€ 52,50
1000207	7018.32	32	18,5	14,5		8003150457757	€ 67,00
1000208	7018.36	36	20,5	20,0		8003150457764	€ 84,00
1000209	7018.40	40	22,5	27,2		8003150457771	€ 108,00
1000210	7018.45	45	25,0	38,7		8003150457788	€ 134,00
1000211	7018.50	50	28,0	53,5		8003150457795	€ 154,00
1001773	7018.60	60	31,0	88,0		8003150457801	€ 234,00

## 7021

Corpo casseruola per cuocipasta - ricambio



SAP	Ref.	Ø cm	H	Lt	Pack.	EAN	Prezzo cons.*
1001776	7021.28	28	18,5	11,0		8003150509623	€ 71,50
1001777	7021.32	32	21,0	15,0		8003150509630	€ 83,00
1001778	7021.36	36	22,0	21,5		8003150509647	€ 110,00
1001779	7021.40	40	25,0	30,5		8003150509654	€ 140,00

## 7020

Casseruola alta 2 maniglie



SAP	Ref.	Ø cm	H	Lt	Pack.	EAN	Prezzo cons.*
1001774	7020.20	20	14,5	4,2		8003150457818	€ 36,00
1001775	7020.24	24	16,0	7,0		8003150457825	€ 48,00
1004464	7020.28	28	18,5	11,0		8003150457832	€ 70,00
1004465	7020.32	32	21,0	15,0		8003150457849	€ 83,00
1004466	7020.36	36	22,0	21,5		8003150457856	€ 104,00
1004467	7020.40	40	25,0	30,5		8003150457863	€ 140,00
1001780	7020.45	45	28,0	45,5		8003150457870	€ 170,00
1001781	7020.50	50	30,0	57,5		8003150457887	€ 207,00

## 7022

Pentola 2 maniglie



SAP	Ref.	Ø cm	H	Lt	Pack.	EAN	Prezzo cons.*
1001789	7022.20	20	18,0	5,5		8003150458075	€ 43,00
1001791	7022.24	24	22,0	9,5		8003150458099	€ 57,00
1001792	7022.28	28	27,5	16,5		8003150458112	€ 79,00
1001794	7022.32	32	31,5	25,0		8003150458136	€ 105,00
1001795	7022.36	36	35,0	35,0		8003150458143	€ 150,00
1001796	7022.40	40	38,5	47,5		8003150458150	€ 190,00
1001797	7022.45	45	41,5	65,0		8003150458167	€ 220,00
1001798	7022.50	50	43,5	84,5		8003150458174	€ 280,00
1001799	7022.60	60	60,0	155,0		8003150458181	€ 469,00



# SERIE 7000

2,5 MM - 4 MM - ALLUMINIO BIANCO



## 7024

Casseruola bassa 1 manico



SAP	Ref.	Ø cm	H	Lt	Pack.	EAN	Prezzo cons.*
1000212	7024.20	20	8,0			8003150457900	€ 26,00
1000213	7024.24	24	8,5			8003150457924	€ 31,50
1000214	7024.28	28	10,5			8003150457948	€ 46,50
1000215	7024.32	32	10,5			8003150464694	€ 58,00
1002297	7024.36	36	11,5			8003150464700	€ 70,50

## 7028

Casseruola alta 1 manico



SAP	Ref.	Ø cm	H	Lt	Pack.	EAN	Prezzo cons.*
1001784	7028.16	16	11,0	2,0		8003150458020	€ 28,50
1001785	7028.18	18	13,0	3,0		8003150458037	€ 30,50
1001786	7028.20	20	14,5	4,2		8003150458044	€ 33,50
1001787	7028.24	24	16,0	7,0		8003150458051	€ 44,00
1001788	7028.28	28	18,5	11,0		8003150458068	€ 63,00
1002299	7028.32	32	21,0	15,0		8003150464724	€ 79,00

## 7026

Casseruola media 1 manico



SAP	Ref.	Ø cm	H	Lt	Pack.	EAN	Prezzo cons.*
1000216	7026.16	16	8,5	1,5		8003150457955	€ 22,00
1000217	7026.18	18	10,0	2,3		8003150457962	€ 25,00
1000218	7026.20	20	11,5	3,2		8003150457979	€ 28,50
1000220	7026.24	24	13,5	5,5		8003150457993	€ 39,00
1000221	7026.28	28	16,5	9,3		8003150458013	€ 48,00
1004455	7026.32	32	18,5	14,5		8003150464717	€ 60,00

## 7030

Casseruola conica 1 manico con becco



SAP	Ref.	Ø cm	H	Lt	Pack.	EAN	Prezzo cons.*
1001800	7030.16	16	8,5	1,3		8003150458198	€ 28,50
1001801	7030.18	18	9,0	1,7		8003150458204	€ 30,50
1001802	7030.20	20	11,0	2,4		8003150458211	€ 33,50
1001803	7030.24	24	13,0	4,5		8003150458228	€ 45,00

# SERIE 7000

2,5 MM - 4 MM - ALLUMINIO BIANCO



## 7032

Casseruola ovale 2 maniglie con coperchio



SAP	Ref.	Ø cm	H	Pack.	EAN	Prezzo cons.*
1000222	7032.32	32X23	12,0		8003150458266	€ 86,00
1000223	7032.36	36X27	14,0		8003150458273	€ 103,00

## 7036

Cuocipasta alto 3 spicchi



SAP	Ref.	Ø cm	H	Lt	Pack.	EAN	Prezzo cons.*
1002350	7036.36	36	22,0	21,0		8003150467442	€ 300,00

## 7035

Cuocipasta alto 2 spicchi



SAP	Ref.	Ø cm	H	Lt	Pack.	EAN	Prezzo cons.*
1002709	7035.28	28	18,5	11,0		8003150484005	€ 201,00
1002710	7035.32	32	21,0	15,0		8003150484012	€ 223,00

## 7038

Cuocipasta alto 4 spicchi



SAP	Ref.	Ø cm	H	Lt	Pack.	EAN	Prezzo cons.*
1001871	7038.36	36	22,0	21,0		8003150459058	€ 317,00
1001872	7038.40	40	25,0	30,0		8003150459065	€ 390,00
1002364	7038.50	50	28,0	57,0		8003150468593	€ 467,00

# SERIE 7000

2,5 MM - 4 MM - ALLUMINIO BIANCO



## 7040

Rostiera alta pesante 2 maniglie snodabili



SAP	Ref.	Ø cm	H mm	Pack.	EAN	Prezzo cons.*
1001811	7040.25	25X18	6,5	2,5	8003150458372	€ 37,00
1000224	7040.30	30X22	7,0	3,0	8003150458389	€ 43,00
1000225	7040.35	35X25	7,0	3,0	8003150458396	€ 50,00
1000226	7040.40	40X28	7,0	3,0	8003150458402	€ 62,00
1000227	7040.45	45X33	8,5	3,0	8003150458419	€ 78,00
1000228	7040.50	50X38	9,0	3,0	8003150458426	€ 97,00
1000229	7040.60	60X43	10,0	3,0	8003150458433	€ 123,00

## 7044

Teglia rettangolare bordo svasato - angoli saldati lega 3003



SAP	Ref.	Ø cm	H mm	Pack.	EAN	Prezzo cons.*
1001816	7044.30	30X23	3,0	1,2	8003150458488	€ 18,00
1001817	7044.35	35X28	3,0	1,2	8003150458495	€ 19,00
1001818	7044.40	40X30	3,0	1,2	8003150458501	€ 20,00
1001819	7044.45	45X35	3,0	1,2	8003150458518	€ 23,00
1001820	7044.50	50X35	3,0	1,2	8003150458525	€ 24,00
1001821	7044.60	60X40	3,0	1,5	8003150458532	€ 33,50

## 7041

Coperchio rettangolare piano per rostiera



SAP	Ref.	Ø cm	H mm	Pack.	EAN	Prezzo cons.*
1002615	7041.25	25X18			8003150481318	€ 25,00
1002616	7041.30	30X22			8003150481325	€ 26,00
1002617	7041.35	35X25			8003150481332	€ 29,50
1002618	7041.40	40X28			8003150481349	€ 36,00

## 7046

Teglia rettangolare bordo dritto angoli saldati - lega 3003



SAP	Ref.	Ø cm	H mm	Pack.	EAN	Prezzo cons.*
1002387	7046.10	60X40	1,0	1,5	8003150470411	€ 32,50
1001822	7046.60	60X40	2,0	1,5	8003150458549	€ 33,50
1002611	7046.64	60X40	4,0	1,5	8003150481110	€ 46,00

## 7042

Rostiera bassa pesante bordo dritto 2 maniglie snodabili



SAP	Ref.	Ø cm	H mm	Pack.	EAN	Prezzo cons.*
1001812	7042.40	40X28	6,0	3,0	8003150458440	€ 59,00
1001813	7042.45	45X30	6,0	3,0	8003150458457	€ 70,00
1001814	7042.50	50X33	6,0	3,0	8003150458464	€ 82,00
1001815	7042.60	60X40	6,0	3,0	8003150458471	€ 102,00

## 7047

Vassoio rettangolare angoli stampati - lega 3003



SAP	Ref.	Ø cm	H mm	Pack.	EAN	Prezzo cons.*
1002614	7047.60	60X40	1,2	1,5	8003150481301	€ 41,00

# SERIE 7000

2,5 MM - 4 MM - ALLUMINIO BIANCO



## 7048

Teglia rettangolare bordo dritto, angoli saldati, con fori Ø mm 2 – Lega 3003



SAP	Ref.	Ø cm	H mm	Pack.	EAN	Prezzo cons.*
1001823	7048.60	60X40	2,0	1,5	8003150458556	€ 47,50

## 7049

Vassoio rettangolare angoli stampati, forato, con fori Ø mm 2 – Lega 3003



SAP	Ref.	Ø cm	H mm	Pack.	EAN	Prezzo cons.*
1002610	7049.60	60X40	1,2	1,5	8003150481103	€ 48,50

## 7050

Teglia rettangolare bordo svasato, angoli saldati, forata Ø mm 7 - lega 3003



SAP	Ref.	Ø cm	H mm	Pack.	EAN	Prezzo cons.*
1001824	7050.60	60X40	3,0	1,5	8003150458563	€ 52,50

## 7052

Tortiera cilindrica con anello



SAP	Ref.	Ø cm	H mm	Pack.	EAN	Prezzo cons.*
1001825	7052.20	20	6,0		8003150458570	€ 16,00
1001826	7052.24	24	6,0		8003150458587	€ 17,00
1001827	7052.28	28	6,0		8003150458594	€ 24,00
1001828	7052.32	32	6,0		8003150458600	€ 28,50
1001830	7052.36	36	6,5		8003150458617	€ 34,50
1001831	7052.40	40	6,5		8003150458624	€ 41,00

## 7054

Tortiera conica bassa con bordo



SAP	Ref.	Ø cm	H mm	Pack.	EAN	Prezzo cons.*
1001833	7054.16	16	3,0		8003150458648	€ 7,00
1001834	7054.18	18	3,0		8003150458655	€ 7,50
1001835	7054.20	20	3,0		8003150458662	€ 8,50
1001836	7054.22	22	3,0		8003150458679	€ 9,00
1001837	7054.24	24	3,0		8003150458686	€ 10,50
1001838	7054.26	26	3,0		8003150458693	€ 11,50
1001839	7054.28	28	3,0		8003150458709	€ 14,50
1001840	7054.30	30	3,5		8003150458716	€ 16,50
1001841	7054.32	32	3,5		8003150458723	€ 18,00
1001842	7054.36	36	3,5		8003150458730	€ 21,00
1001843	7054.40	40	3,5		8003150458747	€ 30,50
1001844	7054.45	45	4,0		8003150458754	€ 34,50
1001845	7054.50	50	4,0		8003150458761	€ 44,00

# SERIE 7000

2,5 MM - 4 MM - ALLUMINIO BIANCO



## 7056

Tortiera conica alta con bordo



SAP	Ref.	Ø cm	H	Pack.	EAN	Prezzo cons.*
1001846	7056.22	22	5,5		8003150458778	€ 9,00
1001847	7056.24	24	5,5		8003150458785	€ 10,00
1001848	7056.26	26	6,0		8003150458792	€ 12,00
1001849	7056.28	28	6,0		8003150458808	€ 13,50
1001850	7056.30	30	6,5		8003150458815	€ 18,00
1001851	7056.32	32	6,5		8003150458822	€ 19,00

## 7058

Coperchio piano



SAP	Ref.	Ø cm	H	Pack.	EAN	Prezzo cons.*
1001852	7058.16	16			8003150458839	€ 9,50
1001853	7058.18	18			8003150458846	€ 10,50
1000230	7058.20	20			8003150458853	€ 12,00
1000232	7058.24	24			8003150458877	€ 15,00
1001855	7058.28	28			8003150458891	€ 17,00
1001857	7058.32	32			8003150458914	€ 21,00
1001858	7058.36	36			8003150458921	€ 24,00
1001859	7058.40	40			8003150458938	€ 29,50
1001860	7058.45	45			8003150458945	€ 37,00
1001861	7058.50	50			8003150458952	€ 44,00
1001862	7058.60	60			8003150458969	€ 71,00

## 7057

Colafritto



SAP	Ref.	Ø cm	H	Pack.	EAN	Prezzo cons.*
1002385	7057.40	40			8003150470329	€ 61,00
1002386	7057.50	50			8003150470336	€ 76,00

## 7059

Coperchio ovale



SAP	Ref.	Ø cm	H	Pack.	EAN	Prezzo cons.*
1002284	7059.32	32			8003150464472	€ 29,50
1002285	7059.36	36			8003150464489	€ 35,50

## 7060

Colapasta conico 2 maniglie



SAP	Ref.	Ø cm	H	Pack.	EAN	Prezzo cons.*
1001768	7060.32	32	16		8003150457672	€ 96,00
1001863	7060.36	36	18		8003150458976	€ 113,00
1001864	7060.40	40	20		8003150458983	€ 134,00

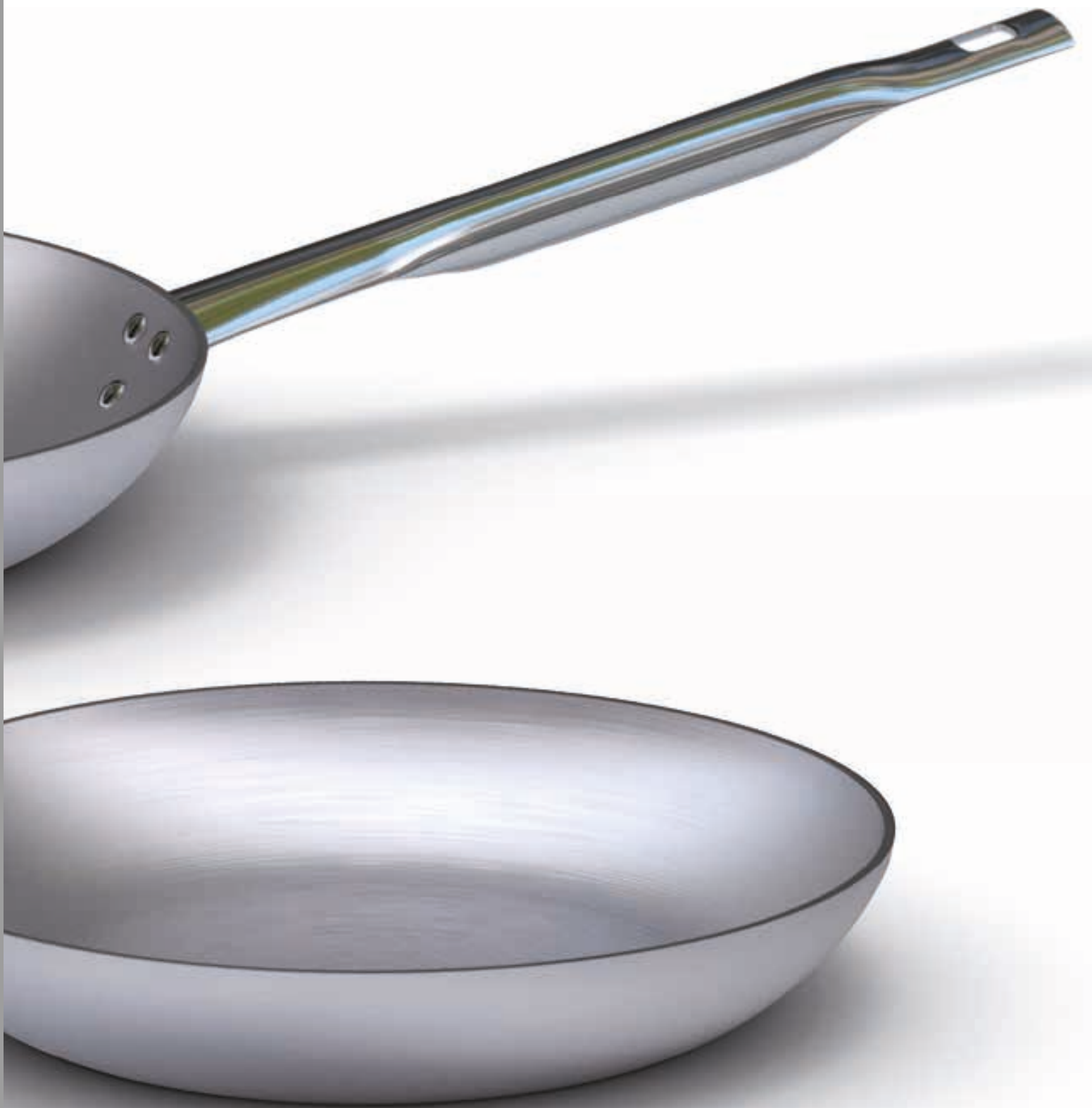

# SERIE 7000

2,5 MM - 4 MM - ALLUMINIO BIANCO



## 7061

Colapasta cilindrico 2 maniglie



SAP	Ref.	Ø cm	H	Pack.	EAN	Prezzo cons.*
1002287	7061.32*	32	31		8003150464564	€ 183,00

\*da utilizzare con art. 7022 di pari diametro

## 7064\*\*

Scaldapasta per cuocipasta 3 spicchi



SAP	Ref.	Ø cm	H	Pack.	EAN	Prezzo cons.*
1002349	7064.36	36	23		8003150467435	€ 59,00

\*\*da utilizzare solo in recipienti in alluminio

## 7062

Scaldapasta conico 1 manico



SAP	Ref.	Ø cm	H	Pack.	EAN	Prezzo cons.*
1001869	7062.24	24	13,0		8003150459034	€ 34,50
1001870	7062.26	26	14,0		8003150459041	€ 37,00

## 7070\*\*

Scaldapasta per cuocipasta 4 spicchi



SAP	Ref.	Ø cm	H	Pack.	EAN	Prezzo cons.*
1002347	7070.36	36	23		8003150467411	€ 52,50
1002348	7070.40	40	26		8003150467428	€ 62,00
1002361	7070.50	50	29		8003150467794	€ 72,00

\*\*da utilizzare solo in recipienti in alluminio

## 7063\*\*

Scaldapasta per cuocipasta 2 spicchi

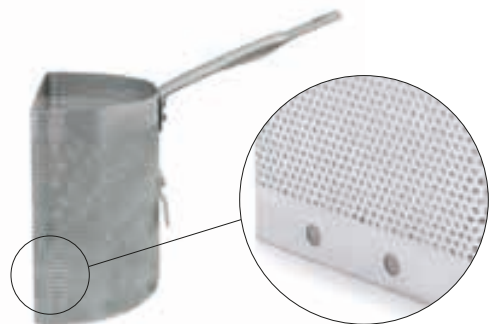

SAP	Ref.	Ø cm	H	PACK.	EAN	Prezzo cons.*
1002713	7063.28	28	20,0		8003150484050	€ 65,00
1002714	7063.32	32	22,5		8003150484067	€ 77,00

\*\*da utilizzare solo in recipienti in alluminio

# SERIE 2000

2,5 - 4 MM - ALLUMINIO ANTIADERENTE

**LINEA IN LEGA DI ALLUMINIO  
CON RIVESTIMENTO ANTIADERENTE  
PROFESSIONALE**

Made in Italy



Rivestimento  
interno

Spessore costante

2,5 mm e 4 mm

Finitura esterna

Alluminio satinato







### Manicatura

Manicatura professionale in acciaio inox a nervatura rinforzata

### Fondo

Fondo ad alto spessore costante per un'ottima distribuzione e assorbimento del calore.

### Fonti di riscaldamento

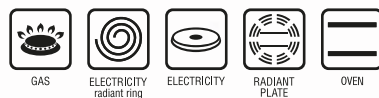

SERIE **2000**  
2,5 MM - 4 MM - ALLUMINIO ANTIADERENTE



**2000**

Padella svasata bassa 1 manico



SAP	Ref	Ø	H	PACK.	EAN	Prezzo cons.*
1000020	2000.20	20	4,0	6 PZ.	8003150456286	€ 30,50
1000021	2000.24	24	4,5	6 PZ.	8003150456293	€ 38,50
1000022	2000.28	28	5,0	6 PZ.	8003150456309	€ 48,00
1000023	2000.32	32	5,0	6 PZ.	8003150456316	€ 57,00
1000024	2000.36	36	5,5	3 PZ.	8003150456323	€ 71,00
1000025	2000.40	40	6,0	3 PZ.	8003150456330	€ 82,00
1001710	2000.45	45	6,5	3 PZ.	8003150456347	€ 118,00

**2003**

Padella svasata alta 1 manico + maniglia



SAP	Ref	Ø	H	PACK.	EAN	Prezzo cons.*
1003704	2003.45	45	10,0		8003150513361	€ 135,00

**2002**

Padella svasata alta 1 manico



SAP	Ref	Ø	H	PACK.	EAN	Prezzo cons.*
1000026	2002.20	20	5,5	6 PZ.	8003150456217	€ 32,50
1000027	2002.24	24	7,0	6 PZ.	8003150456224	€ 40,00
1000028	2002.28	28	7,0	6 PZ.	8003150456231	€ 52,50
1000029	2002.32	32	7,5	6 PZ.	8003150456248	€ 60,50
1000030	2002.36	36	8,0	3 PZ.	8003150456255	€ 80,00
1000031	2002.40	40	8,5	3 PZ.	8003150456262	€ 90,50
1000032	2002.45	45	10,0	3 PZ.	8003150456279	€ 135,00

**2004**

Padella dritta "a friggere" 1 manico



SAP	Ref	Ø	H	PACK.	EAN	Prezzo cons.*
1001703	2004.20	20	5,5	6 PZ.	8003150456132	€ 34,50
1001704	2004.24	24	6,0	6 PZ.	8003150456149	€ 42,00
1001705	2004.28	28	6,5	6 PZ.	8003150456156	€ 52,50
1000033	2004.32	32	6,5	6 PZ.	8003150456163	€ 60,50
1001706	2004.36	36	6,5	3 PZ.	8003150456170	€ 80,00

**2006**

Wok "a mantecare" 1 manico



SAP	Ref	Ø	H	PACK.	EAN	Prezzo cons.*
1000034	2006.24	24	7,5		8003150456712	€ 50,00
1000035	2006.28	28	8,8		8003150456729	€ 59,00

# SERIE 2000

2,5 MM - 4 MM - ALLUMINIO ANTIADERENTE



## 2007

### Padella crêpes 1 manico



SAP	Ref	Ø	H	PACK.	EAN	Prezzo cons.*
1000036	2007.25	25			8003150465189	€ 41,00

## 2008

### Tegame 2 maniglie



SAP	Ref	Ø	H	PACK.	EAN	Prezzo cons.*
1001711	2008.20	20	5,5	6 PZ.	8003150456354	€ 36,50
1001712	2008.24	24	6,0	6 PZ.	8003150456361	€ 43,00
1000037	2008.28	28	6,5	6 PZ.	8003150456378	€ 54,00
1000038	2008.32	32	6,5	6 PZ.	8003150456385	€ 60,50
1000039	2008.36	36	6,5	3 PZ.	8003150456392	€ 80,00
1000040	2008.40	40	7,0	3 PZ.	8003150456408	€ 92,00
1000041	2008.45	45	8,0	3 PZ.	8003150456415	€ 137,00
1000042	2008.50	50	8,5	3 PZ.	8003150456422	€ 195,00

## 2016

### Casseruola bassa 2 maniglie



SAP	Ref	Ø	H	Lt	PACK.	EAN	Prezzo cons.*
1001713	2016.20	20	8,0	2,3		8003150456439	€ 48,00
1001714	2016.24	24	8,5	3,6		8003150456446	€ 58,00
1000043	2016.28	28	10,5	6,0		8003150456453	€ 78,00
1000044	2016.32	32	10,5	8,0		8003150456460	€ 98,00
1001716	2016.36	36	11,5	11,0		8003150456477	€ 117,00
1001717	2016.40	40	14,0	16,6		8003150456484	€ 146,00
1001718	2016.45	45	16,0	24,6		8003150456491	€ 172,00

## 2018

### Casseruola media 2 maniglie



SAP	Ref	Ø	H	Lt	PACK.	EAN	Prezzo cons.*
1003705	2018.20	20	11,5	3,2		8003150456545	€ 44,00
1000045	2018.24	24	13,5	5,5		8003150456552	€ 60,50
1000046	2018.28	28	16,5	9,2		8003150456569	€ 89,50
1004434	2018.32	32	18,5	14,5		8003150456576	€ 112,00
1001723	2018.36	36	20,5	20,0		8003150456583	€ 141,00
1004480	2018.40	40	22,5	27,2		8003150456590	€ 167,00
1001725	2018.45	45	25,0	38,7		8003150456606	€ 193,00

# SERIE 2000

2,5 MM - 4 MM - ALLUMINIO ANTIADERENTE



## 2024

Casseruola bassa 1 manico



SAP	Ref	Ø	H	Lt	PACK.	EAN	Prezzo cons.*
1000047	2024.20	20	8,0	2,3		8003150456507	€ 38,50
1000048	2024.24	24	8,5	3,6		8003150456521	€ 58,00
1001721	2024.28	28	10,5	6,0		8003150456538	€ 78,00

## 2040

Rostiera alta pesante 2 maniglie snodabili



SAP	Ref	cm	mm	H	PACK.	EAN	Prezzo cons.*
1000053	2040.30	30X22	3,0	6,5		8003150456804	€ 70,00
1001740	2040.35	35X25	3,0	7,0		8003150456811	€ 80,00
1000054	2040.40	40X28	3,0	8,0		8003150456828	€ 95,00
1001741	2040.45	45X33	3,0	8,5		8003150456835	€ 119,00
1001742	2040.50	50X38	3,0	9,0		8003150456842	€ 140,00
1001743	2040.60	60X43	3,0	10,0		8003150456859	€ 182,00

## 2026

Casseruola media 1 manico



SAP	Ref	Ø	H	Lt	PACK.	EAN	Prezzo cons.*
1000049	2026.16	16	8,5	1,5		8003150456613	€ 38,50
1001726	2026.18	18	10,0	2,3		8003150456620	€ 48,00
1000050	2026.20	20	11,5	3,2		8003150456637	€ 52,50
1000051	2026.24	24	13,5	5,5		8003150456651	€ 60,50
1001728	2026.28	28	16,0	9,2		8003150456668	€ 89,50

## 2044

Teglia rettangolare angoli svasati saldati



SAP	Ref	cm	H	PACK.	EAN	Prezzo cons.*
1001746	2044.35	35X28	3,0		8003150456897	€ 36,50
1001747	2044.40	40X30	3,0		8003150456903	€ 43,00
1001748	2044.45	45X35	3,0		8003150456910	€ 54,00
1001749	2044.50	50X35	3,0		8003150456927	€ 57,00
1001750	2044.60	60X40	3,0		8003150456934	€ 79,00



# SERIE 2100

3 MM - ALLUMINIO ANTIADERENTE

**LINEA IN LEGA DI ALLUMINIO  
CON RIVESTIMENTO ANTIADERENTE  
PROFESSIONALE**

Made in Italy

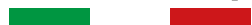

**Rivestimento  
interno**

**Spessore costante**

3,0 mm

**Finitura esterna**

Ad altissima resistenza termica,  
antimacchia, facile da pulire





### Manicatura

Manicatura professionale  
in acciaio inox a nervatura rinforzata

### Fondo

Fondo ad alto spessore costante  
per un'ottima distribuzione  
e assorbimento del calore.

### Fonti di riscaldamento

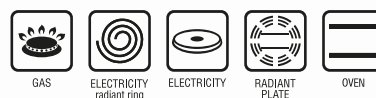

# SERIE 2100

3 MM - ALLUMINIO ANTIADERENTE



## 2100

Padella svasata bassa 1 manico



SAP	Ref	Ø	H	PACK.	EAN	Prezzo cons.*
1006401	2100.20	20	4,0	6 PZ.	8003150511886	€ 30,50
1006402	2100.24	24	4,5	6 PZ.	8003150511893	€ 40,00
1006403	2100.28	28	5,0	6 PZ.	8003150511909	€ 48,00
1006404	2100.32	32	5,0	6 PZ.	8003150511916	€ 58,00
1006405	2100.36	36	5,5	3 PZ.	8003150511923	€ 72,00
1006451	2100.40	40	6,0	3 PZ.	8003150512197	€ 84,00

## 2108

Tegame 2 maniglie



SAP	Ref	Ø	H	PACK.	EAN	Prezzo cons.*
1006411	2108.24	24	6,0	6 PZ.	8003150511985	€ 45,00
1006412	2108.28	28	6,5	6 PZ.	8003150511992	€ 59,00
1006429	2108.32	32	6,5	6 PZ.	8003150512166	€ 62,50
1006413	2108.36	36	6,5	3 PZ.	8003150512005	€ 83,00
1006453	2108.40	40	7,0	3 PZ.	8003150512210	€ 95,00

## 2102

Padella svasata alta 1 manico



SAP	Ref	Ø	H	PACK.	EAN	Prezzo cons.*
1006406	2102.20	20	5,5	6 PZ.	8003150511930	€ 33,50
1006407	2102.24	24	7,0	6 PZ.	8003150511947	€ 41,00
1006408	2102.28	28	7,0	6 PZ.	8003150511954	€ 54,00
1006409	2102.32	32	7,5	6 PZ.	8003150511961	€ 61,50
1006410	2102.36	36	8,0	3 PZ.	8003150511978	€ 82,00
1006452	2102.40	40	8,5	3 PZ.	8003150512203	€ 93,00

## 2116

Casseruola bassa 2 maniglie



SAP	Ref	Ø	H	Lt	PACK.	EAN	Prezzo cons.*
1006422	2116.24	24	8,5	3,6		8003150512098	€ 59,00
1006423	2116.28	28	10,5	6,0		8003150512104	€ 80,00
1006424	2116.32	32	10,5	8,0		8003150512111	€ 101,00
1006425	2116.36	36	11,5	11,0		8003150512128	€ 121,00



# SERIE 2100

3 MM - ALLUMINIO ANTIADERENTE



## 2118

Casseruola media 2 maniglie



SAP	Ref	Ø	H	Lt	PACK.	EAN	Prezzo cons.*
1006414	2118.20	20	11,5	3,2		8003150512012	€ 48,00
1006415	2118.24	24	13,5	5,5		8003150512029	€ 64,50
1006416	2118.28	28	16,5	9,2		8003150512036	€ 92,00
1006417	2118.32	32	18,5	14,5		8003150512043	€ 121,00
1006418	2118.36	36	20,5	20,0		8003150512050	€ 144,00

## 2126

Casseruola media 1 manico



SAP	Ref	Ø	H	Lt	PACK.	EAN	Prezzo cons.*
1006419	2126.16	16	8,5	1,5		8003150512067	€ 42,00
1006420	2126.20	20	10,0	3,2		8003150512074	€ 54,00
1006421	2126.24	24	13,5	5,5		8003150512081	€ 63,00

## 2124

Casseruola bassa 1 manico



SAP	Ref	Ø	H	Lt	PACK.	EAN	Prezzo cons.*
1006426	2124.20	20	8,0	2,3		8003150512135	€ 41,00
1006427	2124.24	24	8,5	3,6		8003150512142	€ 60,00
1006428	2124.28	28	10,5	6,0		8003150512159	€ 85,00

# SERIE **2800**

3 MM - ALLUMINIO ANTIADERENTE

## LINEA IN LEGA DI ALLUMINIO CON RIVESTIMENTO ANTIADERENTE PROFESSIONALE

Made in Italy



### Finitura esterna

Alluminio satinato

### Spessore costante

3,0 mm

Rivestimento  
interno



### Fondo

Fondo ad alto spessore costante per un'ottima distribuzione e mantenimento del calore.





### Manicatura

Manicatura professionale in acciaio inox a nervatura rinforzata.

### Fonti di riscaldamento

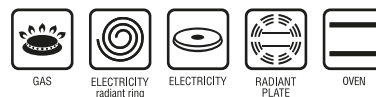

# SERIE 2800

3 MM - ALLUMINIO ANTIADERENTE



## 2800

Padella svasata bassa 1 manico



SAP	Ref	Ø	H	PACK.	EAN	Prezzo cons.*
1000062	2800.24	24	4,5		8003150481585	€ 45,00
1000064	2800.28	28	5,0		8003150481592	€ 56,00
1000066	2800.32	32	5,0		8003150481608	€ 67,00
1002627	2800.36	36	5,5		8003150481615	€ 82,00
1000068	2800.40	40	6,0		8003150481622	€ 98,00

## 2808

Tegame 2 maniglie



SAP	Ref	Ø	H	PACK.	EAN	Prezzo cons.*
1000076	2808.28	28	6,5		8003150483107	€ 60,50
1004425	2808.32	32	6,5		8003150483114	€ 72,50
1002685	2808.36	36	6,5		8003150483121	€ 93,50
1002686	2808.40	40	7,0		8003150483138	€ 111,00

## 2802

Padella svasata alta 1 manico



SAP	Ref	Ø	H	PACK.	EAN	Prezzo cons.*
1000069	2802.24	24	7,0	6 pz.	8003150481639	€ 48,00
1000071	2802.28	28	7,0	6 pz.	8003150481646	€ 60,00
1000073	2802.32	32	7,5	6 pz.	8003150481653	€ 70,00
1000074	2802.36	36	8,0	3 pz.	8003150481660	€ 92,00
1000075	2802.40	40	8,5	3 pz.	8003150481677	€ 107,00

## 2818

Casseruola media 2 maniglie



SAP	Ref	Ø	H	Lt	PACK.	EAN	Prezzo cons.*
1002872	2818.28	28	16,5	9,2		8003150489284	€ 99,00
1002873	2818.32	32	18,5	14,5		8003150489291	€ 125,00

## 2826

Casseruola media 1 manico



SAP	Ref	Ø	H	Lt	PACK.	EAN	Prezzo cons.*
1002874	2826.16	16	8,5	1,5		8003150489307	€ 44,00
1000080	2826.20	20	11,5	3,2		8003150489314	€ 48,00
1002875	2826.24	24	13,5	5,5		8003150489321	€ 66,00



# SERIE 6800

4 MM - ALLUMINIO BIANCO

## LINEA PROFESSIONALE IN ALLUMINIO

Made in Italy

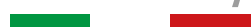

### Finitura esterna

Alluminio lavato decapato  
neutralizzato

### Finitura interna

Alluminio lavato decapato  
neutralizzato

### Spessore costante

4,0 mm

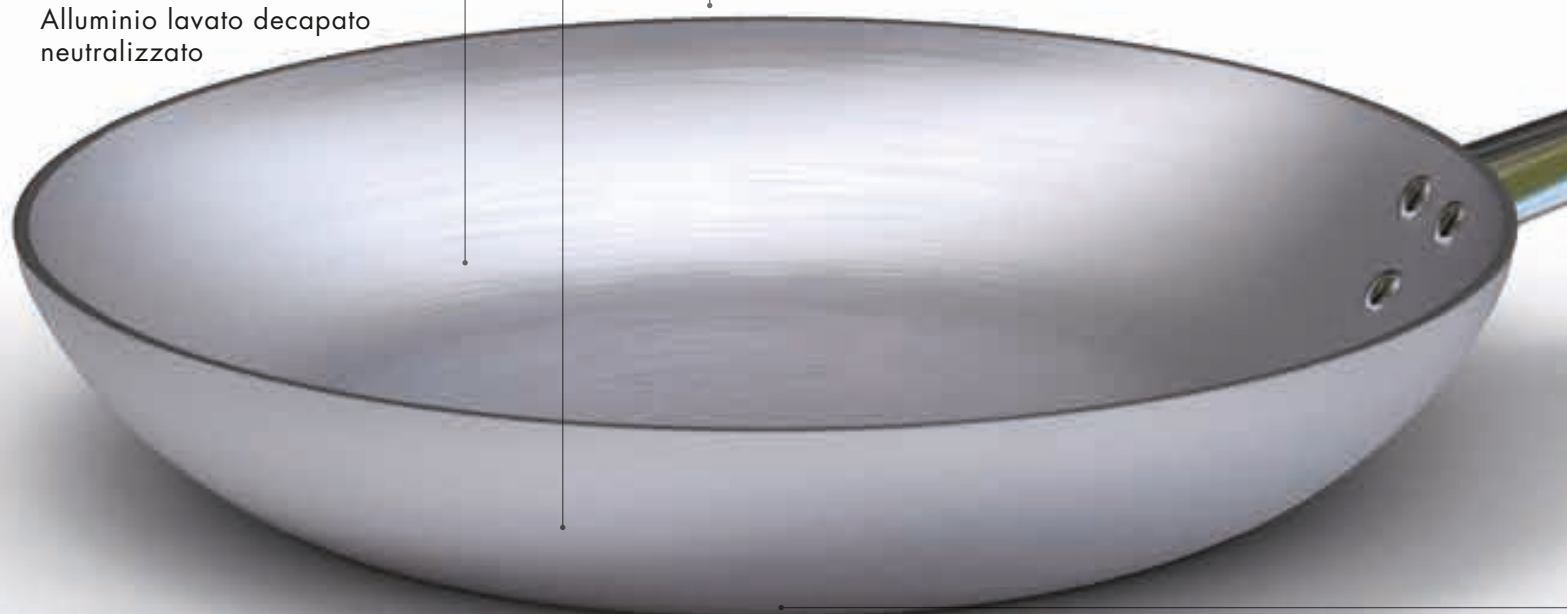

**INDUCTION**



### Manicatura

Manicatura professionale in acciaio inox a nervatura rinforzata

### Fondo **INDUCTION**

Fondo ad alto spessore costante per un'ottima distribuzione e mantenimento del calore.

Anti-distacco e adatto per tutte le fonti di calore, induzione compresa



### Fonti di riscaldamento





# SERIE 6800

4 MM - ALLUMINIO BIANCO



## 6800

Padella svasata bassa 1 manico



SAP	Ref	Ø	Ø	H	PACK.	EAN	Prezzo cons.*
1010049	6800.20	20	14,5	4,0	6 PZ.	8003150517468	€ 39,00
1010050	6800.24	24	16	4,5	6 PZ.	8003150517475	€ 46,50
1010051	6800.28	28	18	5,0	6 PZ.	8003150517482	€ 52,50
1010052	6800.32	32	21	5,0	3 PZ.	8003150517499	€ 60,00
1010053	6800.36	36	24	5,5	3 PZ.	8003150517505	€ 71,50

## 6804

Padella dritta "a friggere" 1 manico



SAP	Ref	Ø	Ø	H	PACK.	EAN	Prezzo cons.*
1010058	6804.24	24	18	6,0	6 PZ.	8003150517550	€ 47,50
1010059	6804.28	28	21	6,5	6 PZ.	8003150517567	€ 55,00
1010060	6804.32	32	24	6,5	3 PZ.	8003150517574	€ 63,00

## 6802

Padella svasata alta 1 manico



SAP	Ref	Ø	Ø	H	PACK.	EAN	Prezzo cons.*
1010054	6802.28	28	14,5	7,0	6 PZ.	8003150517512	€ 55,00
1010055	6802.32	32	18	7,5	3 PZ.	8003150517529	€ 66,50
1010056	6802.36	36	21	8,0	3 PZ.	8003150517536	€ 76,00
1010057	6802.40	40	24	8,5	3 PZ.	8003150517543	€ 88,50

## 6808

Tegame 2 maniglie



SAP	Ref	Ø	Ø	H	PACK.	EAN	Prezzo cons.*
1010061	6808.24	24	18	6,0	-	8003150517581	€ 55,00
1010062	6808.28	28	21	6,5	-	8003150517598	€ 64,00
1010063	6808.32	32	24	6,5	-	8003150517604	€ 71,50



**INDUCTION**

# SERIE 6800

4 MM - ALLUMINIO BIANCO

**BALLARINI**  
1889  
*Professionale*

## 6826

Casseruola media 1 manico



**INDUCTION**

SAP	Ref	Ø	Ø	H	Lt	PACK.	EAN	Prezzo cons.*
1010064	6826.20	20	14,5	11,5	3,2	-	8003150517611	€ 60,00
1010065	6826.24	24	18	13,5	5,5	-	8003150517628	€ 68,00

## 6818

Casseruola media 2 maniglie



**INDUCTION**

SAP	Ref	Ø	Ø	H	Lt	PACK.	EAN	Prezzo cons.*
1010066	6818.20	20	14,5	11,5	3,2	-	8003150517635	€ 68,50
1010067	6818.24	24	18	13,5	5,5	-	8003150517642	€ 80,00
1010068	6818.28	28	21	16,5	9,2	-	8003150517659	€ 88,50



Istruzioni per un uso corretto degli articoli a induzione

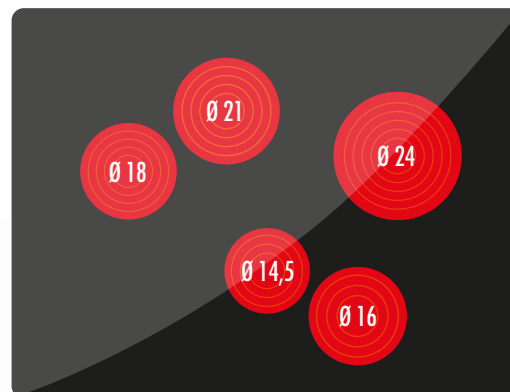

\*Prezzo consigliato al pubblico e non vincolante

# SERIE 6700

4 MM - ALLUMINIO ANTIADERENTE

## LINEA IN LEGA DI ALLUMINIO CON RIVESTIMENTO ANTIADERENTE PROFESSIONALE

Made in Italy



### Finitura esterna

Alluminio satinato

### Spessore costante

4,0 mm



Rivestimento  
interno

### Manicatura

Manicatura professionale  
in acciaio inox a nervatura  
rinforzata



**INDUCTION**

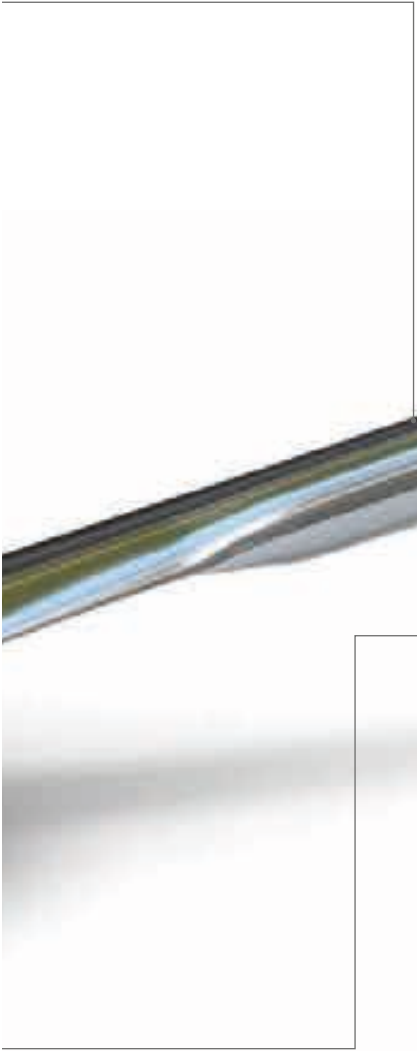

Fondo **INDUCTION**

Fondo ad alto spessore costante per un'ottima distribuzione e mantenimento del calore.

Anti-distacco e adatto per tutte le fonti di calore, induzione compresa



Fonti di riscaldamento

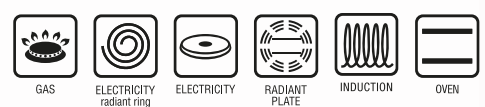

**INDUCTION**

# SERIE 6700

4 MM - ALLUMINIO ANTIADERENTE



**BALLARINI**  
1889  
*Professionale*

**6700**

Padella svasata bassa 1 manico

**INDUCTION**

SAP	Ref	Ø	Ø	H	PACK.	EAN	Prezzo cons.*
1010009	6700.20	20	14,5	4,0	6 PZ.	8003150517055	€ 42,00
1010010	6700.24	24	16	4,5	6 PZ.	8003150517062	€ 49,50
1010011	6700.28	28	18	5,0	6 PZ.	8003150517079	€ 55,00
1010012	6700.32	32	21	5,0	3 PZ.	8003150517093	€ 63,00
1010013	6700.36	36	24	5,5	3 PZ.	8003150517109	€ 77,00

**6704**

Padella dritta "a friggere" 1 manico

**INDUCTION**

SAP	Ref	Ø	Ø	H	PACK.	EAN	Prezzo cons.*
1010018	6704.24	24	18	6,0	6 PZ.	8003150517154	€ 49,50
1010019	6704.28	28	21	6,5	6 PZ.	8003150517161	€ 59,00
1010020	6704.32	32	24	6,5	3 PZ.	8003150517178	€ 65,00

**6702**

Padella svasata alta 1 manico

**INDUCTION**

SAP	Ref	Ø	Ø	H	PACK.	EAN	Prezzo cons.*
1010014	6702.28	28	14,5	7,0	6 PZ.	8003150517116	€ 58,00
1010015	6702.32	32	18	7,5	3 PZ.	8003150517123	€ 67,00
1010016	6702.36	36	21	8,0	3 PZ.	8003150517130	€ 81,00
1010017	6702.40	40	24	8,5	3 PZ.	8003150517147	€ 94,00

**6708**

Tegame 2 maniglie

**INDUCTION**

SAP	Ref	Ø	Ø	H	PACK.	EAN	Prezzo cons.*
1010021	6708.24	24	18	6,0	-	8003150517185	€ 58,00
1010022	6708.28	28	21	6,5	-	8003150517192	€ 66,50
1010023	6708.32	32	24	6,5	-	8003150517208	€ 73,50



# SERIE 6700

4 MM - ALLUMINIO ANTIADERENTE



## 6726

Casseruola media 1 manico



SAP	Ref	Ø	Ø	H	Lt	PACK.	EAN	Prezzo cons.*
1010024	6726.20	20	14,5	11,5	3,2	-	8003150517215	€ 63,00
1010025	6726.24	24	18	13,5	5,5	-	8003150517222	€ 71,00

## 6718

Casseruola media 2 maniglie



SAP	Ref	Ø	Ø	H	Lt	PACK.	EAN	Prezzo cons.*
1010026	6718.20	20	14,5	11,5	3,2	-	8003150517239	€ 73,50
1010027	6718.24	24	18	13,5	5,5	-	8003150517246	€ 83,00
1010028	6718.28	28	21	16,5	9,2	-	8003150517253	€ 99,90



Istruzioni per un uso corretto degli articoli a induzione

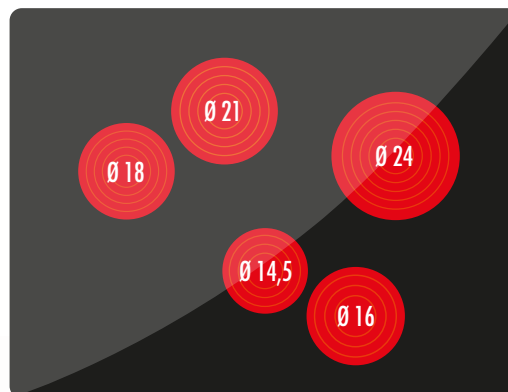

\*Prezzo consigliato al pubblico e non vincolante

# SERIE 6900

4 MM - ALLUMINIO ANTIADERENTE

## LINEA IN LEGA DI ALLUMINIO CON RIVESTIMENTO ANTIADERENTE PROFESSIONALE

Made in Italy



### Finitura esterna

Alluminio satinato

### Spessore costante

4,0 mm



Rivestimento  
interno



**INDUCTION**

**BALLARINI**  
1889  
*Professionale*



### Manicatura

Manicatura professionale in acciaio inox a nervatura rinforzata



Fondo **INDUCTION**

Fondo ad alto spessore costante per un'ottima distribuzione e mantenimento del calore.

Antidistacco e adatto per tutte le fonti di calore, induzione compresa



### Fonti di riscaldamento

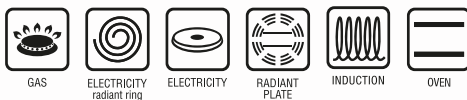



# SERIE 6900

4 MM - ALLUMINIO ANTIADERENTE



## 6900

Padella svasata bassa 1 manico



SAP	Ref	Ø	Ø	H	PACK.	EAN	Prezzo cons.*
1010072	6900.20	20	14,5	4,0	6 PZ.	8003150517673	€ 52,50
1010074	6900.24	24	16	4,5	6 PZ.	8003150517680	€ 58,00
1010075	6900.28	28	18	5,0	6 PZ.	8003150517697	€ 68,00
1010076	6900.32	32	21	5,0	3 PZ.	8003150517703	€ 79,00
1010077	6900.36	36	24	5,5	3 PZ.	8003150517710	€ 89,00

## 6904

Padella dritta "a friggere" 1 manico



SAP	Ref	Ø	Ø	H	PACK.	EAN	Prezzo cons.*
1010082	6904.24	24	18	6,0	6 PZ.	8003150517765	€ 66,00
1010083	6904.28	28	21	6,5	6 PZ.	8003150517772	€ 75,50
1010084	6904.32	32	24	6,5	3 PZ.	8003150517789	€ 91,00

## 6902

Padella svasata alta 1 manico



SAP	Ref	Ø	Ø	H	PACK.	EAN	Prezzo cons.*
1010078	6902.28	28	14,5	7,0	6 PZ.	8003150517727	€ 75,50
1010079	6902.32	32	18	7,5	3 PZ.	8003150517734	€ 91,50
1010080	6902.36	36	21	8,0	3 PZ.	8003150517741	€ 94,50
1010081	6902.40	40	24	8,5	3 PZ.	8003150517758	€ 105,00

## 6908

Tegame 2 maniglie



SAP	Ref	Ø	Ø	H	PACK.	EAN	Prezzo cons.*
1010085	6908.24	24	18	6,0	-	8003150517796	€ 68,00
1010086	6908.28	28	21	6,5	-	8003150517802	€ 79,00
1010087	6908.32	32	24	6,5	-	8003150517819	€ 89,00





# SERIE 6900

4 MM - ALLUMINIO ANTIADERENTE



## 6926

Casseruola media 1 manico



SAP	Ref	Ø	Ø	H	Lt	PACK.	EAN	Prezzo cons.*
1010088	6926.20	20	14,5	11,5	3,2	-	8003150517826	€ 68,00
1010089	6926.24	24	18	13,5	5,5	-	8003150517833	€ 79,00



Istruzioni per un uso corretto degli articoli a induzione

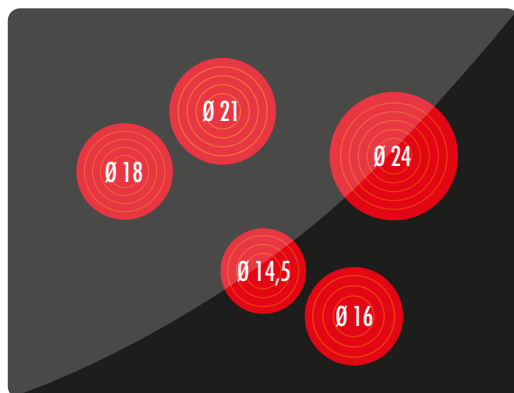

## 6918

Casseruola media 2 maniglie



SAP	Ref	Ø	Ø	H	Lt	PACK.	EAN	Prezzo cons.*
1010090	6918.20	20	14,5	11,5	3,2	-	8003150517840	€ 79,00
1010091	6918.24	24	18	13,5	5,5	-	8003150517857	€ 94,00
1010092	6918.28	28	21	16,5	9,2	-	8003150517864	€ 105,00

# SERIE 6000

4 MM - ALLUMINIO ANTIADERENTE

## LINEA IN LEGA DI ALLUMINIO CON RIVESTIMENTO ANTIADERENTE PROFESSIONALE

Made in Italy



Spessore costante

4,0 mm



Rivestimento  
interno

Finitura esterna

Ad altissima resistenza termica,  
antimacchia, facile da pulire



**INDUCTION**

**BALLARINI**  
1889  
*Professionale*



### Manicatura

Manicatura professionale  
in acciaio inox a nervatura rinforzata

Fondo **INDUCTION**

Fondo ad alto spessore costante  
per un'ottima distribuzione  
e mantenimento del calore.

Anti-distaccamento e adatto  
per tutte le fonti di calore,  
induzione compresa

### Fonti di riscaldamento

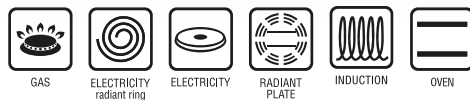



# SERIE 6000

4 MM - ALLUMINIO ANTIADERENTE



## 6000

Padella svasata bassa 1 manico



SAP	Ref	Ø	Ø	H	PACK.	EAN	Prezzo cons.*
1010029	6000.20	20	14,5	4,0	6 PZ.	8003150517260	€ 58,00
1010030	6000.24	24	16	4,5	6 PZ.	8003150517277	€ 68,00
1010031	6000.28	28	18	5,0	6 PZ.	8003150517284	€ 79,00
1010032	6000.32	32	21	5,0	3 PZ.	8003150517291	€ 93,00
1010033	6000.36	36	24	5,5	3 PZ.	8003150517307	€ 100,00

## 6004

Padella dritta "a friggere" 1 manico



SAP	Ref	Ø	Ø	H	PACK.	EAN	Prezzo cons.*
1010038	6004.24	24	18	6,0	6 PZ.	8003150517352	€ 70,00
1010039	6004.28	28	21	6,5	6 PZ.	8003150517369	€ 79,00
1010040	6004.32	32	24	6,5	3 PZ.	8003150517376	€ 94,00

## 6002

Padella svasata alta 1 manico



SAP	Ref	Ø	Ø	H	PACK.	EAN	Prezzo cons.*
1010034	6002.28	28	14,5	5,5	6 PZ.	8003150517314	€ 82,00
1010035	6002.32	32	18	7,0	3 PZ.	8003150517321	€ 99,00
1010036	6002.36	36	21	7,0	3 PZ.	8003150517338	€ 107,00
1010037	6002.40	40	24	7,5	3 PZ.	8003150517345	€ 131,00

## 6008

Tegame a 2 maniglie



SAP	Ref	Ø	Ø	H	PACK.	EAN	Prezzo cons.*
1010041	6008.24	24	18	6,0	-	8003150517383	€ 76,00
1010042	6008.28	28	21	6,5	-	8003150517390	€ 86,00
1010043	6008.32	32	24	6,5	-	8003150517406	€ 101,00



# SERIE 6000

4 MM - ALLUMINIO ANTIADERENTE



## 6026

Casseruola media 1 manico



SAP	Ref	Ø	Ø	H	Lt	PACK.	EAN	Prezzo cons.*
1010044	6026.20	20	14,5	11,5	3,2	-	8003150517413	€ 69,00
1010045	6026.24	24	18	13,5	5,5	-	8003150517420	€ 87,00

## 6007

Crepiera 1 manico



SAP	Ref	Ø	Ø	PACK.	EAN	Prezzo cons.*
1010113	6007.30	30	24	-	8003150517888	€ 73,00

## 6018

Casseruola media 2 maniglie



SAP	Ref	Ø	Ø	H	Lt	PACK.	EAN	Prezzo cons.*
1010046	6018.20	20	14,5	11,5	3,2	-	8003150517437	€ 82,00
1010047	6018.24	24	18	13,5	5,5	-	8003150517444	€ 97,00
1010048	6018.28	28	21	16,5	9,2	-	8003150517451	€ 120,00



Istruzioni per un uso corretto degli articoli a induzione

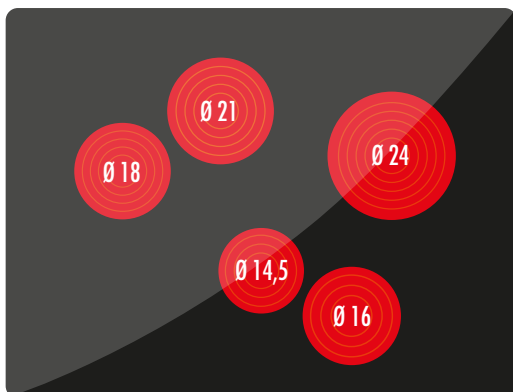

\*Prezzo consigliato al pubblico e non vincolante

# SERIE 9200

ACCIAIO INOX 18/10

## LINEA PROFESSIONALE IN ACCIAIO INOX 18/10

### Fondo

**INDUCTION**

Fondo termo diffusore sandwich a tre strati: acciaio/alluminio/acciaio, adatto per tutte le fonti di calore incluse quelle ad induzione



### Finitura interna

Acciaio spazzolato

### Finitura esterna

Satinatura esterna per una più lunga durata estetica nel tempo



**INDUCTION**

**BALLARINI**  
1889  
*Professionale*



### Manicatura

Manicatura professionale in acciaio tubolare per un'ottima presa, saldata con flangia di rinforzo. Maniglia dalla presa ampia e solida



### Fonti di riscaldamento

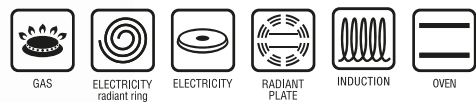



# SERIE 9200

ACCIAIO INOX 18/10



## 9200

### Padella bassa 1 manico



SAP	Ref	Ø	H	PACK.	EAN	Prezzo cons.*
1006289	9200.20	20	5,0	-	8003150510773	€ 43,00
1006290	9200.24	24	5,5	-	8003150510780	€ 50,00
1006291	9200.28	28	6,0	-	8003150510797	€ 60,00
1006292	9200.32	32	6,0	-	8003150510803	€ 77,00
1006293	9200.36	36	7,0	-	8003150510810	€ 98,00
1006294	9200.40	40	8,0	-	8003150510827	€ 138,00

## 9216

### Casseruola bassa 2 maniglie



SAP	Ref	Ø	H	Lt	PACK.	EAN	Prezzo cons.*
1006303	9216.20	20	7,0	2,0	-	8003150510919	€ 43,00
1006304	9216.24	24	8,0	3,3	-	8003150510926	€ 60,00
1006305	9216.28	28	9,0	5,0	-	8003150510933	€ 79,00
1006306	9216.32	32	10,0	7,2	-	8003150510940	€ 106,00
1006307	9216.36	36	11,0	10,1	-	8003150510957	€ 137,00
1006308	9216.40	40	13,0	14,7	-	8003150510964	€ 171,00
1006309	9216.45	45	14,0	20,0	-	8003150510971	€ 226,00
1006310	9216.50	50	16,0	28,3	-	8003150510988	€ 308,00
1006311	9216.60	60	18,0	45,8	-	8003150510995	€ 482,00

## 9201

### Padella Inox antiaderente 1 manico



SAP	Ref	Ø	H	PACK.	EAN	Prezzo cons.*
1006295	9201.24	24	5,5	-	8003150510834	€ 64,00
1006296	9201.28	28	6,0	-	8003150510841	€ 80,00
1006297	9201.32	32	6,0	-	8003150510858	€ 104,00

## 9218

### Casseruola media 2 maniglie



SAP	Ref	Ø	H	Lt	PACK.	EAN	Prezzo cons.*
1006312	9218.18	18	8,0	1,8	-	8003150511008	€ 38,00
1006313	9218.20	20	9,0	2,5	-	8003150511015	€ 45,00
1006314	9218.24	24	10,5	4,3	-	8003150511022	€ 62,00
1006315	9218.28	28	12,0	6,7	-	8003150511039	€ 80,00
1006316	9218.32	32	15,0	10,9	-	8003150511046	€ 116,00
1006317	9218.36	36	17,0	15,6	-	8003150511053	€ 152,00
1006318	9218.40	40	19,0	21,5	-	8003150511060	€ 193,00
1006319	9218.45	45	22,0	31,5	-	8003150511077	€ 263,00
1006320	9218.50	50	24,0	42,4	-	8003150511084	€ 355,00
1006321	9218.60	60	25,0	63,6	-	8003150511091	€ 534,00

## 9208

### Tegame 2 maniglie



SAP	Ref	Ø	H	PACK.	EAN	Prezzo cons.*
1006298	9208.24	24	5,5	-	8003150510865	€ 48,00
1006299	9208.28	28	6,0	-	8003150510872	€ 60,00
1006300	9208.32	32	6,0	-	8003150510889	€ 76,00
1006301	9208.36	36	7,0	-	8003150510896	€ 101,00
1006302	9208.40	40	8,0	-	8003150510902	€ 142,00





# SERIE 9200

ACCIAIO INOX 18/10



## 9220

Casseruola alta 2 maniglie



SAP	Ref	Ø	H	Lt	PACK.	EAN	Prezzo cons.*
1006322	9220.18	18	12,0	2,7	-	8003150511107	€ 44,00
1006323	9220.20	20	13,0	3,7	-	8003150511114	€ 50,50
1006324	9220.24	24	15,0	6,1	-	8003150511121	€ 68,00
1006325	9220.28	28	17,0	9,4	-	8003150511138	€ 93,00
1006326	9220.32	32	19,0	13,8	-	8003150511145	€ 125,00
1006327	9220.36	36	22,0	20,2	-	8003150511152	€ 163,00
1006328	9220.40	40	25,0	28,3	-	8003150511169	€ 212,00
1006329	9220.45	45	28,0	40,1	-	8003150511176	€ 290,00
1006330	9220.50	50	30,0	53	-	8003150511183	€ 420,00
1006331	9220.60	60	35,0	89,1	-	8003150511190	€ 600,00

## 9222

Pentola 2 maniglie



SAP	Ref	Ø	H	Lt	PACK.	EAN	Prezzo cons.*
1006332	9222.16	16	16,0	1,1	-	8003150511213	€ 45,00
1006333	9222.18	18	18,0	4,1	-	8003150511220	€ 52,50
1006334	9222.20	20	20,0	5,7	-	8003150511237	€ 65,00
1006335	9222.24	24	24,0	9,8	-	8003150511244	€ 89,00
1006336	9222.28	28	28,0	15,5	-	8003150511251	€ 125,00
1006337	9222.32	32	32,0	23,2	-	8003150511268	€ 172,00
1006338	9222.36	36	36,0	33	-	8003150511275	€ 222,00
1006339	9222.40	40	40,0	45,2	-	8003150511282	€ 303,00
1006340	9222.45	45	45,0	64,4	-	8003150511299	€ 375,00
1006341	9222.50	50	50,0	88,4	-	8003150511305	€ 519,00
1006342	9222.60	60	55,0	140	-	8003150511312	€ 772,00

## 9226

Casseruola media 1 manico



SAP	Ref	Ø	H	Lt	PACK.	EAN	Prezzo cons.*
1006356	9226.16	16	7,0	1,3	-	8003150511459	€ 37,00
1006357	9226.18	18	8,0	1,8	-	8003150511466	€ 40,00
1006358	9226.20	20	9,0	2,5	-	8003150511473	€ 52,50
1006359	9226.24	24	10,5	4,3	-	8003150511480	€ 60,00
1006360	9226.28	28	12,0	6,7	-	8003150511497	€ 77,00

## 9228

Casseruola alta 1 manico



SAP	Ref	Ø	H	Lt	PACK.	EAN	Prezzo cons.*
1006347	9228.16	16	11,0	2	-	8003150511367	€ 41,00
1006348	9228.18	18	12,0	2,7	-	8003150511374	€ 45,00
1006349	9228.20	20	13,0	3,7	-	8003150511381	€ 51,00
1006350	9228.24	24	15,0	6,1	-	8003150511398	€ 64,00
1006351	9228.28	28	17,0	9,4	-	8003150511404	€ 86,50

**INDUCTION**

# SERIE 9200

ACCIAIO INOX 18/10



**BALLARINI**  
1889  
*Professionale*

## 9236

Cuocipasta alto 3 spicchi Inox  
in lamiera microforata

**INDUCTION**

SAP	Ref	Ø	H	PACK.	EAN	Prezzo cons.*
1006470	9236.36	36	-	-	8003150512388	€ 468,00

## 9258

Coperchio piano



SAP	Ref	Ø	H	PACK.	EAN	Prezzo cons.*
1006361	9258.16	16	-	-	8003150511503	€ 14,00
1006362	9258.18	18	-	-	8003150511510	€ 15,00
1006363	9258.20	20	-	-	8003150511527	€ 16,00
1006364	9258.24	24	-	-	8003150511534	€ 20,00
1006365	9258.28	28	-	-	8003150511541	€ 24,00
1006366	9258.32	32	-	-	8003150511558	€ 32,50
1006367	9258.36	36	-	-	8003150511565	€ 39,00
1006368	9258.40	40	-	-	8003150511572	€ 52,00
1006369	9258.45	45	-	-	8003150511589	€ 61,00
1006370	9258.50	50	-	-	8003150511596	€ 71,00
1006371	9258.60	60	-	-	8003150511602	€ 117,00

## 9239

Cuocipasta alto 4 spicchi Inox  
in lamiera microforata

**INDUCTION**

SAP	Ref	Ø	H	PACK.	EAN	Prezzo cons.*
1006472	9239.40	40	-	-	8003150512401	€ 642,00

## 9060

Colapasta conico con base 2 maniglie



SAP	Ref	Ø	H	PACK.	EAN	Prezzo cons.*
1002022	9060.28	28	13,0	-	8003150460627	€ 132,00
1002023	9060.32	32	16,0	-	8003150460634	€ 149,00
1002024	9060.36	36	18,0	-	8003150460641	€ 168,00
1002025	9060.40	40	20,0	-	8003150460658	€ 191,00
1002026	9060.45	45	22,0	-	8003150460665	€ 211,00
1002027	9060.50	50	24,0	-	8003150460672	€ 258,00



# SERIE 9200

ACCIAIO INOX 18/10



## 9063\*

Scaldapasta inox in lamiera microforata 1/2 con gancio, per cuocipasta

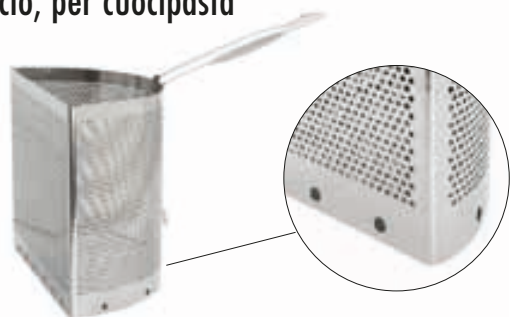

SAP	Ref	Ø	H	PACK.	EAN	Prezzo cons.*
1004411	9063.36	36	23	-	8003150467725	€ 113,00

\*da utilizzare solo in recipienti in acciaio inox

## 9070\*

Scaldapasta inox in lamiera microforata 1/4 con gancio, per cuocipasta

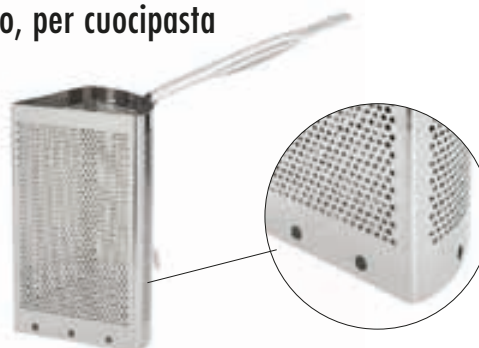

SAP	Ref	Ø	H	PACK.	EAN	Prezzo cons.*
1004408	9070.36	36	23,0	-	8003150460405	€ 95,00
1004409	9070.40	40	26,0	-	8003150460412	€ 108,00

\*da utilizzare solo in recipienti in acciaio inox

## 9065\*

Scaldapasta inox in lamiera microforata 1/3 con gancio, per cuocipasta



SAP	Ref	Ø	H	PACK.	EAN	Prezzo cons.*
1004410	9065.36	36	23,0	-	8003150467718	€ 102,00

\*da utilizzare solo in recipienti in acciaio inox

## 9072

Cestello\* per cottura a vapore 2 maniglie



SAP	Ref	Ø	H	Lt	PACK.	EAN	Prezzo cons.*
1002008	9072.28	28	17,0	10,0	-	8003150460450	€ 122,00
1002009	9072.32	32	19,0	15,0	-	8003150460467	€ 152,00

\*Per inserimento su art. 9220-9222 pari diametro

# SERIE 9200

ACCIAIO INOX 18/10



## 9074

Scaldapasta cilindrico 1 manico



SAP	Ref	Ø	H	Lt	PACK.	EAN	Prezzo cons.*
1002017	9074.20	20	12,0	3,6	-	8003150460566	€ 80,00
1004390	9074.24	24	14,0	6,5	-	8003150460573	€ 100,00
1002468	9074.28	28	15,0	9,3	-	8003150474792	€ 126,00

\*da utilizzare solo in recipienti in acciaio inox

## 9078

Colapasta sferico 2 maniglie



SAP	Ref	Ø	H	Lt	PACK.	EAN	Prezzo cons.*
1002028	9078.32	32	18,0	9,5	-	8003150460689	€ 167,00
1003707	9078.36	36	19,0	12,0	-	8003150460696	€ 223,00
1003708	9078.40	40	21,0	14,5	-	8003150460702	€ 267,00

## 9076

Colino cinese 1 manico



SAP	Ref	Ø	H	PACK.	EAN	Prezzo cons.*
1002030	9076.16	16	13,0	-	8003150460719	€ 41,00
1002031	9076.18	18	15,0	-	8003150460726	€ 42,00
1002035	9076.22	22	20,0	-	8003150460740	€ 48,00

## 9080

Bastardella 2 maniglie



SAP	Ref	Ø	H	Lt	PACK.	EAN	Prezzo cons.*
1002038	9080.22	22	12,0	2,7	-	8003150460764	€ 69,00
1002039	9080.26	26	14,0	4,0	-	8003150460771	€ 89,00
1002040	9080.32	32	18,0	9,5	-	8003150460788	€ 116,00
1002041	9080.36	36	20,5	14,0	-	8003150460795	€ 172,00
1002042	9080.40	40	21,5	18,0	-	8003150460801	€ 183,00

# SERIE 9200

ACCIAIO INOX 18/10



## 9082

Base per bastardella



SAP	Ref	cm	H	PACK.	EAN	Prezzo cons.*
1002043	9082.22	22X26		-	8003150460818	€ 37,00
1002044	9082.32	32X36		-	8003150460825	€ 47,50

## 9088

Pesciera con griglia e coperchio



SAP	Ref	cm	H	PACK.	EAN	Prezzo cons.*
1002881	9088.50	48X16	11,5	-	8003150489413	€ 128,00

## 9084

Bagnomaria 1 manico



SAP	Ref	Ø	H	Lt	PACK.	EAN	Prezzo cons.*
1002010	9084.14	14	16,0	2,4	-	8003150460474	€ 78,00
1002011	9084.16	16	18,0	3,5	-	8003150460481	€ 88,00
1002013	9084.18	18	20,0	5,0	-	8003150460498	€ 98,00
1004400	9084.20	20	22,0	6,8	-	8003150460504	€ 113,00

SERIE **9200**

ACCIAIO INOX 18/10 - ACCESSORI E MESTOLAME



## IL MESTOLAME



**EURO  
HOLE**

Tutto il mestolame è disponibile  
in packaging dotato di Euro Hole  
per favorire la sospensione a parete



SERIE **9200**  
ACCIAIO INOX 18/10  
**ACCESSORI E MESTOLAME**



**9090**  
Mestolo unipezzo

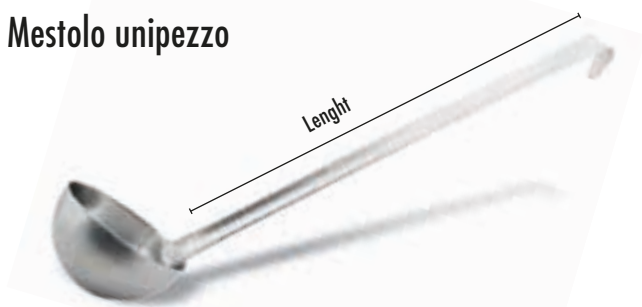

SAP	Ref	cm	Length cm	C.C.	PACK.	EAN	Prezzo cons.*
1002045	9090.06	6,5	29,0	0,07	-	8003150460849	€ 25,50
1002046	9090.08	8,0	33,0	0,12	-	8003150460856	€ 28,50
1002048	9090.09	9,0	33,0	0,20	-	8003150460863	€ 29,50
1002049	9090.10	10,0	36,0	0,25	-	8003150460870	€ 34,00
1002050	9090.12	12,0	40,0	0,50	-	8003150460887	€ 35,00
1002051	9090.14	14,0	44,0	0,75	-	8003150460894	€ 44,00
1002053	9090.16	16,0	48,0	1,0	-	8003150460900	€ 47,00

**9092**  
Paletta liscia

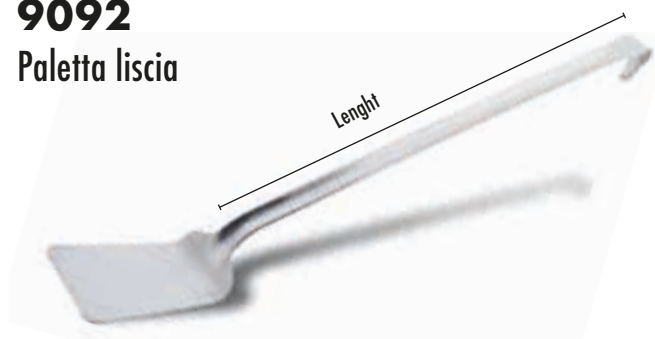

SAP	Ref	cm	Length cm	C.C.	PACK.	EAN	Prezzo cons.*
1002063	9092.11	11	44,0	-	-	8003150460979	€ 30,50

**9091**  
Schiumarola

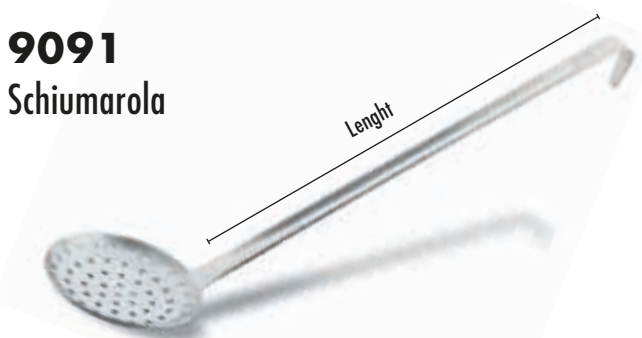

SAP	Ref	cm	Length cm	C.C.	PACK.	EAN	Prezzo cons.*
1002055	9091.10	10	29,0	-	-	8003150460917	€ 22,00
1002056	9091.12	12	33,0	-	-	8003150460924	€ 24,00
1002057	9091.14	14	36,0	-	-	8003150460931	€ 28,50
1002058	9091.16	16	44,0	-	-	8003150460948	€ 33,50
1002060	9091.18	18	44,0	-	-	8003150460955	€ 37,00
1002061	9091.20	20	45,0	-	-	8003150460962	€ 39,00

**9093**  
Paletta forata



SAP	Ref	cm	Length cm	C.C.	PACK.	EAN	Prezzo cons.*
1002066	9093.11	11	44,0	-	-	8003150460993	€ 30,50

**9094**  
Cucchiaione

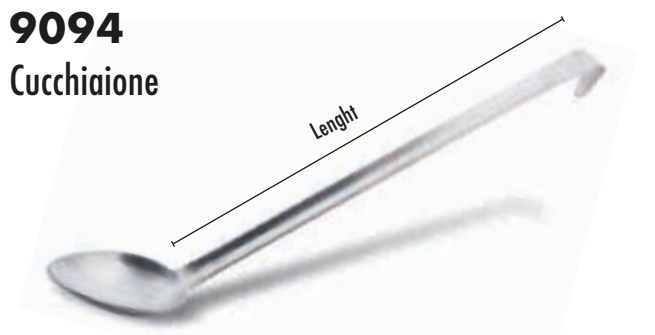

SAP	Ref	cm	Length cm	C.C.	PACK.	EAN	Prezzo cons.*
1002068	9094.08	8,0	36,0	0,10	-	8003150461013	€ 25,00



SERIE **9200**  
ACCIAIO INOX 18/10  
**ACCESSORI E MESTOLAME**



**9095**  
Cucchiaione obliquo

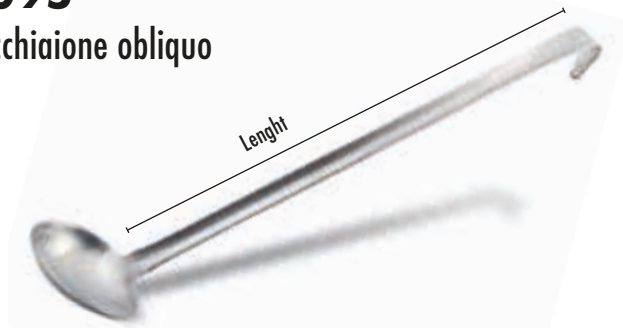

SAP	Ref	cm	Length cm	C.C.	PACK.	EAN	Prezzo cons.*
1002070	9095.08	8,0	36,0	0,10	-	8003150461020	€ 25,00

**9096**  
Forchettone 2 punte

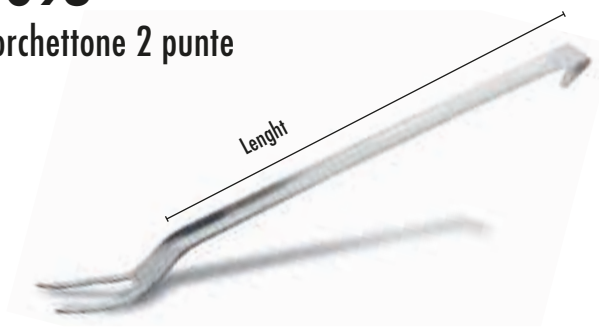

SAP	Ref	cm	Length cm	C.C.	PACK.	EAN	Prezzo cons.*
1002071	9096.50		48,0		-	8003150461037	€ 21,00

**9097**  
Forchettone 3 punte

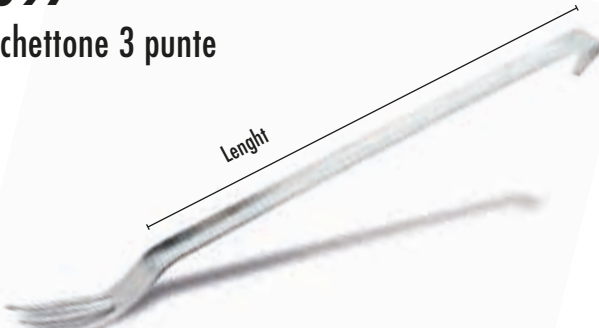

SAP	Ref	cm	Length cm	C.C.	PACK.	EAN	Prezzo cons.*
1002072	9097.50		57,0		-	8003150461044	€ 21,00

**9098**  
Frusta 12 fili flessibile

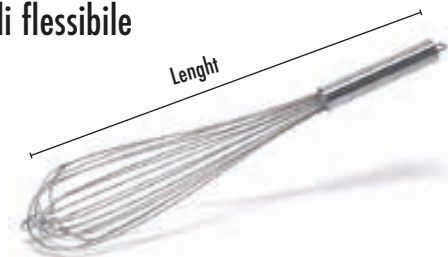

SAP	Ref	cm	Length cm	C.C.	PACK.	EAN	Prezzo cons.*
1002073	9098.25		25,0		-	8003150461051	€ 8,00
1002074	9098.30		30,0		-	8003150461068	€ 8,50
1002075	9098.35		35,0		-	8003150461075	€ 9,50
1002076	9098.40		40,0		-	8003150461082	€ 10,50
1002077	9098.45		45,0		-	8003150461099	€ 11,50
1002078	9098.50		50,0		-	8003150461105	€ 14,00

**9099**  
Frusta 8 fili rigida

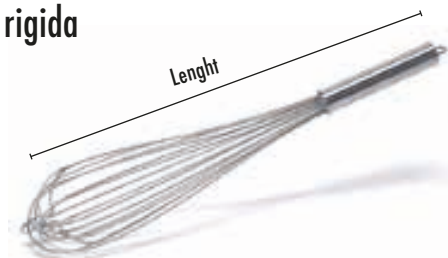

SAP	Ref	cm	Length cm	C.C.	PACK.	EAN	Prezzo cons.*
1002079	9099.25		25,0		-	8003150461112	€ 9,50
1002080	9099.30		30,0		-	8003150461129	€ 10,50
1002081	9099.35		35,0		-	8003150461136	€ 10,50
1002082	9099.40		40,0		-	8003150461143	€ 14,00
1002353	9099.45		45,0		-	8003150467619	€ 15,00
1002354	9099.50		50,0		-	8003150467626	€ 15,00

SERIE **9200**  
ACCIAIO INOX 18/10  
**ACCESSORI E MESTOLAME**



**9100**

Paletta pesce unipezzo, forata

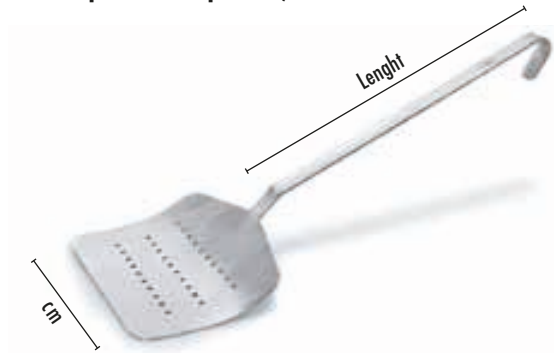

SAP	Ref	cm	Length cm	C.C.	PACK.	EAN	Prezzo cons.*
1002367	9100.34	16	34,0	0,10		8003150468654	€ 24,00

**9102**

Schiumarola a rete larga

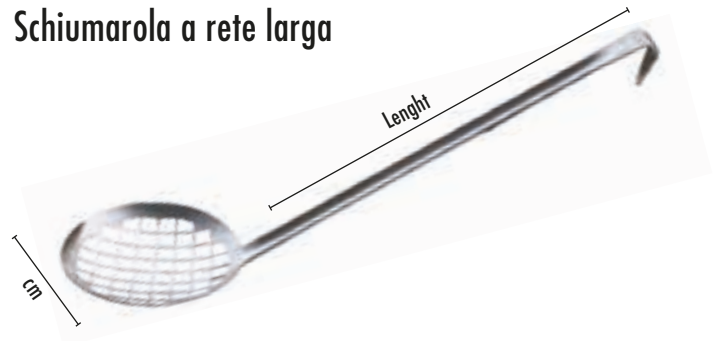

SAP	Ref	cm	Length cm	C.C.	PACK.	EAN	Prezzo cons.*
1004440	9102.14	14	36,0	0,10	-	8003150489468	€ 32,00

**9101**

Schiumarola a rete

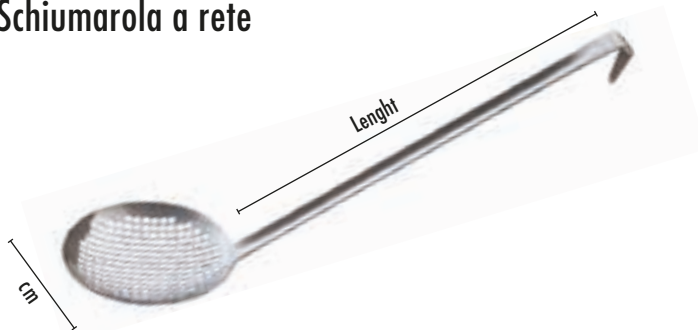

SAP	Ref	cm	Length cm	C.C.	PACK.	EAN	Prezzo cons.*
1004437	9101.11	11	32,0		-	8003150489437	€ 28,00
1004438	9101.14	14	36,0		-	8003150489444	€ 32,00
1004439	9101.18	18	44,0		-	8003150489451	€ 40,00



